

Owner's Guide

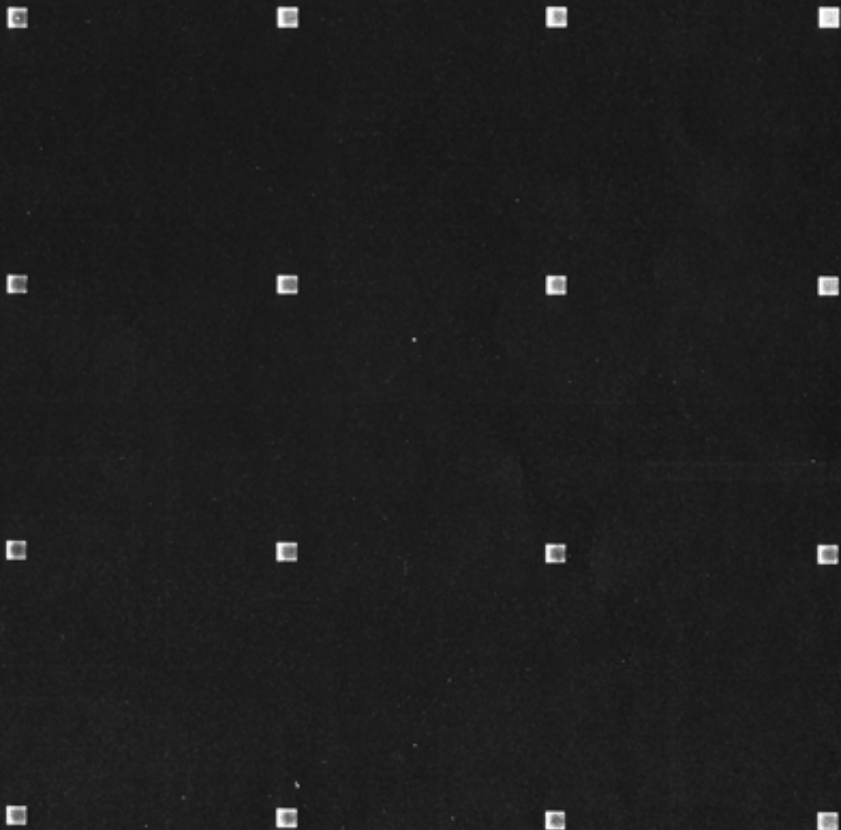



GRiD Compass Owner's Guide

COPYRIGHT © 1984 GRiD Systems Corporation
2535 Garcia Avenue
Mountain View, CA 94043
(415) 961-4800

Manual Name: GRiD Compass Owner's Guide
Issue date: November 1984

No part of this publication may be reproduced, stored in a retrieval system, or transmitted, in any form or by any means, electronic, mechanical, photocopy, recording, or otherwise, without the prior written permission of GRiD Systems Corporation.

The information in this document is subject to change without notice.

Neither GRiD Systems Corporation nor this document makes any expressed or implied warranty, including, but not limited to the implied warranties of merchantability, quality, or fitness for a particular purpose. GRiD Systems Corporation makes no representation as to the accuracy or adequacy of this document. GRiD Systems Corporation has no obligation to update or keep current the information contained in this document.

GRiD Systems Corporation's software products are copyrighted by and shall remain the property of GRiD Systems Corporation.

Under no circumstances will GRiD Systems Corporation be liable for any loss or other damages arising out of the use of this manual.

The following are trademarks of GRiD Systems Corporation: GRiD, GRiD Compass, Compass Computer, GRiD Server.

Limited Warranty and Limitation of Liability

You should carefully read the following terms and conditions. You will be deemed to have accepted these terms and conditions if you have not returned the product with your proof of purchase to your GRiD dealer, within 5 days of the date of payment.

The term "Products", as used herein, means hardware, hardware parts and documentation sold by GRiD.

1. Warranty

GRiD warrants that the Products sold hereunder shall be free from defects in materials and workmanship for a period of 90 days after delivery. Defective Products will be repaired or replaced, at GRiD's option, by GRiD during the warranty period. You shall notify GRiD of the defective Product within the 90 day period, obtain a Product Repair Order and return the Product to GRiD along with proof of purchase data. If this Product is delivered by mail, you agree to insure the Product or assume the risk of loss or damage in transit, to prepay shipping charges to the warranty service location and to use the original shipping container or equivalent. Contact an authorized GRiD Systems dealer or write to: GRiD Systems Corporation, Customer Service Center, 2535 Garcia Avenue, Mountain View, California 94043 for further information.

You are responsible for removing any data or programs or keeping backup copies prior to returning Products to GRiD. GRiD shall not be liable for loss of data contained in any returned equipment.

This warranty is not valid if the Products have been abused, misused, altered, neglected, or if repairs are attempted by unauthorized personnel.

Except as provided above, GRiD makes no warranties, expressed or implied, including any warranty of merchantability or fitness for a particular purpose.

2. Limitation of Liability

In no event will GRiD be liable for special, incidental or consequential damages, however caused. GRiD's liability under or for breach of this agreement shall be limited to refund of the purchase price.

3. General

You shall not assign this Agreement nor any rights hereunder without the prior written consent of GRiD. GRiD reserves the right to withhold such consent for any reason whatsoever. Subject to the foregoing, this Agreement shall bind and inure to the benefit of the respective parties hereto and their heirs, personal representatives, successors and assigns.

The Terms and Conditions of this Limited Warranty and Limitation of Liability and of the Class A Software License Agreement represent the entire Agreement between GRiD and you relating to products purchases and software licensing and may only be modified in writing, signed by both parties.

You acknowledge that you have read this agreement, understand it and agree to be bound by its terms and conditions.



Contents

About This Book 1

Chapter 1: Getting to Know Your GRiD Compass 3

- Checking the Contents of the Box 3
- The Top View 4
- The Rear View 4
 - On/Off Switch 5
 - Power Cord Socket 5
 - Line Voltage Switch 5
 - Fuse 6
 - Serial Connector 6
 - Telephone Connectors 6
 - GPIB Connector 6



Chapter 2: Setting Up the GRiD Compass 7

- Starting Up Your GRiD Compass 7
- The Keyboard 9
- Closing Up Your GRiD Compass 10

Chapter 3: Connecting Peripherals to Your GRiD Compass 11

- Choosing the GPIB or Serial Connector 11
- Connecting Peripherals to the GPIB Connector 12
- Connecting Peripherals to the Serial Connector 14
- Connecting the 2101 Disk System 15
- Connecting the Portable Diskette Drive 17
- Connecting the Epson Printers 18
- Connecting the Diablo Printers 20
- Connecting HP Plotters and the ThinkJet Printer 22

Chapter 4: Using the Modem and Telephone Handset 25

- What Is a Modem? 25
 - Notifying the Telephone Company 26
 - Connecting the Telephone Line 26
 - Adjusting the Speaker Volume 27
 - The Telephone Handset 28
- 



Chapter 5: Troubleshooting 29

- Identifying the Problem 29
 - User Errors in Setting Up the GRiD Compass 29
 - Software or Hardware Problems 30
- Dealing with Radio Frequency Interference 31

Chapter 6: Maintenance 33

- Warnings and Cautions 33
- Cleaning Your GRiD Compass 34
- Storing Your GRiD Compass 35
- Traveling with Your GRiD Compass 35
- Updating the Clock 35

Appendix A: Testing the Modem 37

Appendix B: Switch Settings on Devices 39

- Settings on Disk Devices 39
- Settings on Serial Plotters 40
- Settings on Hayes Smart Modem 40

Index 41

List of Figures and Tables

- Figure 1-1. *Contents of Box* 3
- Figure 1-2. *Top View of the GRiD Compass* 4
- Figure 1-3. *Rear View of the GRiD Compass* 4
- Figure 1-4. *Computer Line Voltage Settings* 5
- Figure 2-1. *GRiD Compass Keyboard* 9
- Figure 3-1. *Peripherals Connected to GPIB Connector* 11
- Figure 3-2. *Peripherals Connected to Serial Connector* 12
- Figure 3-3. *GPIB Cable Connecting GRiD Compass to 2101 Disk System* 13
- Figure 3-4. *Three Peripherals Connected to GRiD Compass* 13
- Figure 3-5. *Two Connected GPIB Cables* 13
- Figure 3-6. *Serial Cables Connecting GRiD Compass to Diablo 630 API Printer* 14
- Figure 3-7. *Front and Rear Views of the 2101 Disk System* 15
- Figure 3-8. *Switch Settings for 2101 Disk System* 16
- Figure 3-9. *Front and Rear Views of the Portable Diskette Drive* 17
- Figure 3-10. *Switch Settings for Portable Diskette Drive* 17

Figure 3-11.	<i>Front and Rear Views of the Epson FX-80 Printer</i>	18
Figure 3-12.	<i>Switch Settings for Epson Printers</i>	19
Figure 3-13.	<i>Paper Aligned in Epson Printer</i>	20
Figure 3-14.	<i>Front and Rear Views of the Diablo 630 API Printer</i>	20
Figure 3-15.	<i>Switch Settings for Diablo Printers</i>	21
Figure 3-16.	<i>Rear View of the Hewlett-Packard 7470A Plotter</i>	23
Figure 3-17.	<i>Switch Settings for Hewlett-Packard Plotters</i>	23
Figure 3-18.	<i>Rear View of the Hewlett-Packard ThinkJet Printer</i>	23
Figure 3-19.	<i>Switch Settings for Hewlett-Packard ThinkJet Printer</i>	24
Figure 4-1.	<i>Communication Inside and Outside the GRiD Family of Products</i>	25
Figure 4-2.	<i>GRiD Compass Connected to Phone Jack</i>	26
Figure 4-3.	<i>Phone and Modem Connected to Telephone System</i>	27
Figure 4-4.	<i>Telephone Handset Connected to GRiD Compass</i>	28
Figure 4-5.	<i>Handset Resting on Cradle</i>	28
Table 5-1.	<i>Troubleshooting Chart</i>	29
Table B-1.	<i>Switch Settings for 2101 Disk System and Portable Diskette Drive</i>	39

WARNING: Radio Interference Possible

This equipment generates, uses, and can radiate radio frequency energy, and if not installed and used in accordance with the instruction manual, may cause interference to radio communications. It has been tested and found to comply with the limits for a Class A computing device pursuant to Subpart J of Part 15 of Federal Communications Commission (FCC) Rules, which are designed to provide reasonable protection against such interference when operated in a commercial environment. Operation of this equipment in a residential area is likely to cause interference, in which case the user at his own expense will be required to take whatever measures may be required to correct the interference (FCC, part 15.818 a). The section "Dealing With Radio Frequency Interference" in Chapter 5 describes some procedures that may correct interference.



About This Book

This manual introduces you to the GRiD Compass™. It shows how to set up your GRiD Compass, and gives the basics of how to operate it.

Once you have a basic understanding of the GRiD Compass, you will be ready to use one of the software applications. To become familiar with the software, see *Getting Started with the GRiD Compass*.



Chapter 1: Getting to Know Your GRiD Compass

This chapter introduces you to your GRiD Compass™. It lists the accessories included with your GRiD Compass and gives a detailed description of the top and rear views of the computer.

Checking the Contents of the Box Figure 1-1 shows the parts included in each shipping carton.

Figure 1-1. *Contents of Box*

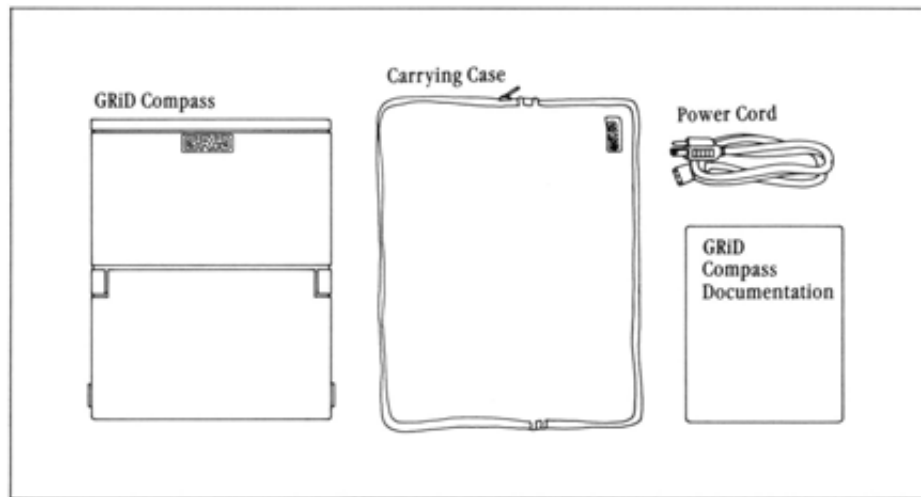

Check for shipping damage or missing parts. If there are any problems, contact a GRiD representative or the store where you purchased your GRiD Compass.

Keep the shipping carton and use it to return your GRiD Compass should it need service.

The Top View The top view of the GRiD Compass is shown in Figure 1-2. Note that the GRiD logo is on the top of the case, toward the rear, and the screen latches are on the sides, toward the front.

Figure 1-2. *Top View of the GRiD Compass*

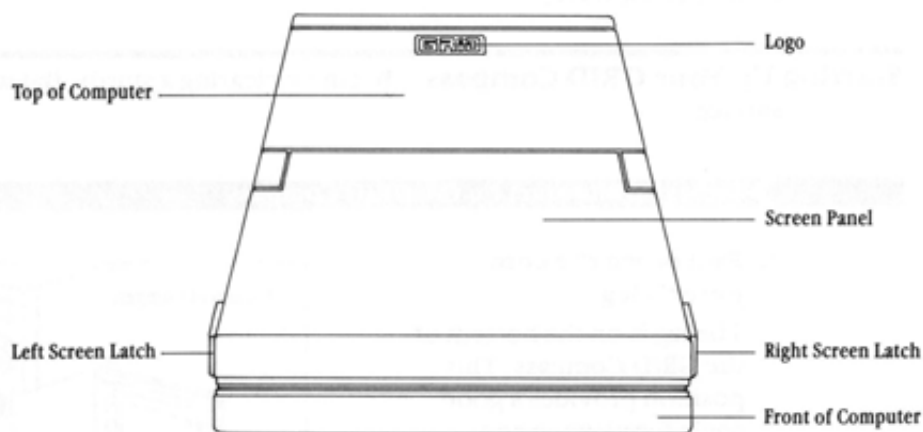

The Rear View The rear view of the GRiD Compass is shown in Figure 1-3. You will use many of the items shown here when setting up your computer.

Figure 1-3. *Rear View of the GRiD Compass*

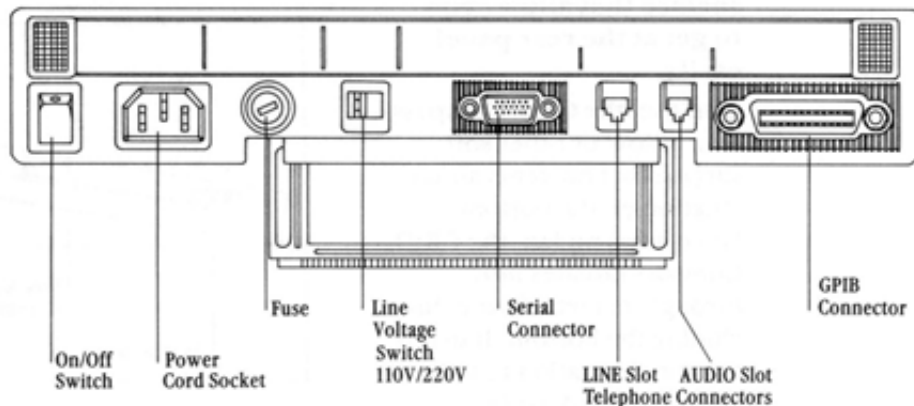

On/Off Switch

The on/off switch, on the far left, turns the computer on and off, and loads some start-up programs into main memory (RAM). When the computer is turned off, a red circle is visible on the top of the switch. To turn on the computer, press the top of the switch. To turn it off, press the bottom of the switch. The switch also functions as a reset switch should you need to reload memory. When you use it as a reset switch, always wait at least five seconds before turning on the computer again. This ensures the software is loaded properly.

NOTE: Optionally, to turn off the computer, disconnect the power plug from the wall.

- ▣ **CAUTION:** Never turn off the computer when the flags on the lower right corner of the screen are flickering. These flags indicate that the computer is reading or writing data; turning off the computer at this time can destroy data.

Power Cord Socket

The power cord socket receives the power cord.

Line Voltage Switch

The line voltage switch lets you switch between 110 volts and 220 volts. See Figure 1-4 below.

Figure 1-4. *Computer Line Voltage Settings*

Set for 110 Volts

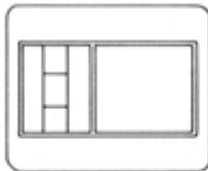

Set for 220 Volts

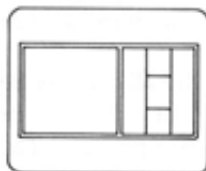

- ▣ **CAUTION:** Always make sure this switch is set properly before plugging the power cord into an electrical outlet. Supplying power through an incorrect voltage setting can damage your computer.

Fuse

The fuse protects your system from potentially harmful electrical input. The fuse that comes with your computer is a one-ampere, slow-blow (AT) fuse for the 110-line-voltage setting. This fuse must have the dimensions $\frac{1}{4}$ " \times $1\frac{1}{4}$ " (6.35mm \times 31.8mm). The Littelfuse type is 3AG; the Fusetron type is MDL.

If you switch to the 220-volt setting, be sure to exchange the one-ampere fuse for a 500-milliampere, super slow-blow (ATT) fuse. This fuse must have the dimensions 5mm \times 20mm ($\frac{1}{5}$ " \times $\frac{4}{5}$ "). The Schurter type is 034.5010. To hold the 500-milliampere fuse, you will also need a fuse holder. Both the fuse and fuse holder are available when you purchase GRiD's European Conversion Kit. To replace the fuse, turn the fuse cover to the left using a small screwdriver and remove the fuse.

- CAUTION:** To protect the system against risk of fire, replace the fuse only with one of the correct rating and type.

Serial Connector

The serial connector is used to connect the GRiD Compass to an external modem, certain printers, and other devices. This connector is an RS-232C and RS-422 compatible connector. Note the trapezoidal or "D" shape; it makes an improper connection impossible. Chapter 3 gives instructions for connecting peripherals to the serial connector.

Telephone Connectors

The GRiD Compass has two telephone connectors. The cord that normally plugs into the back of your phone plugs into the slot marked LINE. The handset cord plugs into the AUDIO slot.

GPIB Connector

The GPIB connector is used to connect the GRiD Compass to most GRiD peripherals. This connector is an IEEE-488 connector. Its trapezoidal shape (like that of the serial connector) ensures a proper connection. Chapter 3 gives instructions for connecting peripherals to the GPIB connector.

Chapter 2: Setting Up the GRiD Compass

This chapter describes how to prepare your GRiD Compass for use. It covers setting up the computer, using the keyboard, and closing up the computer for travel.

Starting Up Your GRiD Compass Begin by clearing a sturdy, flat work surface.

To Set Up and Start Up the GRiD Compass

1. **Pull down the computer's leg.**

The leg is on the bottom of the GRiD Compass. This position provides a good angle for viewing and allows ventilation. Pull down the leg until it clicks into place. Always extend the leg before turning on the computer.

2. **Place the unit on a work surface that allows you to get at the rear panel easily.**

Don't set the GRiD Compass on a pillow or other soft surface that prevents air circulation on the bottom. Since it has no fan, the GRiD Compass radiates heat through its metal frame, including the bottom. It needs free air circulation to keep cool on its underside.

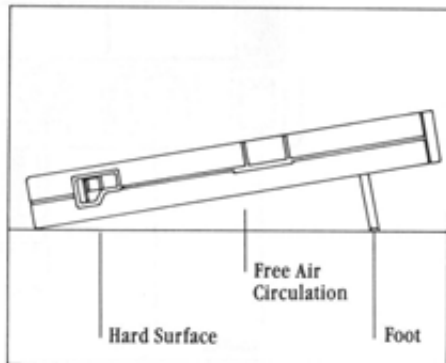
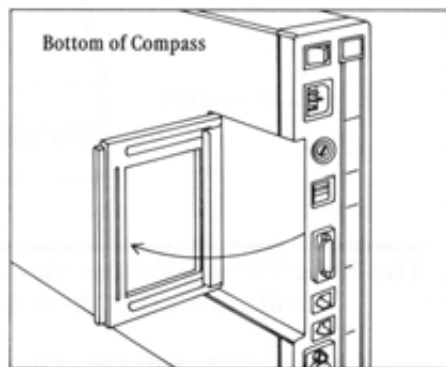

3. Set the voltage line switch at 110 volts (for the U.S.A.).

Outside of the U.S.A., find out what the correct voltage is. If necessary, flip the voltage line switch to 220 volts and change to a 500-milli-ampere, super slow-blow (ATT) fuse (see Chapter 1).

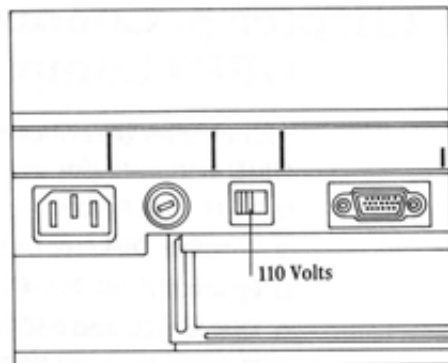

4. Plug in the power cord.

Plug one end of your power cord into the power cord socket at the back of the computer, and the other end into a wall outlet that accepts a three-prong plug. If an adapter is used, make sure it is properly grounded.

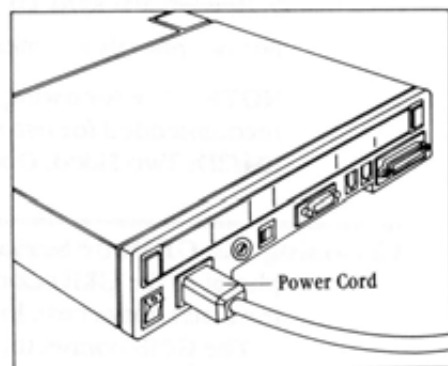

5. Lift up the screen.

The screen is locked to the frame by one latch on each side. Pull these latches toward you and lift the screen.

- CAUTION:** The screen must be treated with care. Never use abrasive substances on the screen. For complete information on cleaning the screen, see the section *Cleaning Your GRiD Compass* in Chapter 6.

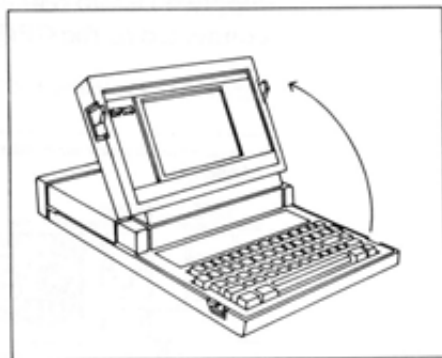

6. Turn on the on/off switch.

The on/off switch is on the back of the GRiD Compass, to the left of the power cord socket. Press the top of this switch to turn on the computer.

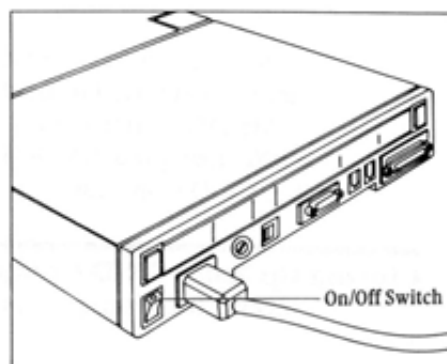

Wait for the software to load. When you turn on the power, the computer loads software from the Bubble Memory (permanent storage) into main memory (RAM). This takes about one minute.

When the loading is finished, the initial operating-system screen is displayed.

NOTE: If you want to connect any other devices to your computer, such as a printer or hard disk, see Chapter 3, "Connecting Peripherals to Your GRiD Compass."

The Keyboard Figure 2-1 shows the keyboard. There are three different types of keys.

- Alphabetic and numeric keys
- Function keys—for issuing commands
- Arrow keys—for positioning the cursor

Figure 2-1. *GRiD Compass Keyboard*

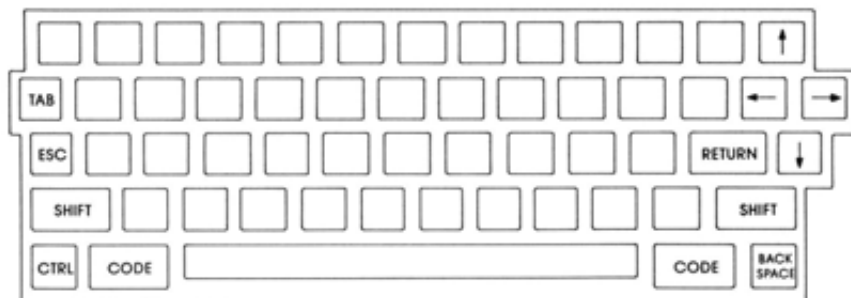

If you are using GRiD-OS (GRiD Operating System), you will learn how to use the keyboard in *Getting Started with the GRiD Compass*.

MS-DOS (Microsoft™—Disk Operating System) users should consult the *GRiD Compass MS-DOS User's Guide* to learn how the keys function on the GRiD Compass.

Closing Up Your GRiD Compass To prepare your GRiD Compass for travel, reverse the setup process.

To Close Up the GRiD Compass

1. Turn off the power.
2. Close the screen panel.
3. Disconnect all cords.
4. Retract the computer leg.

Press it down gently until you hear it click shut.

Pick up and turn the computer so that you can get a good grip on its leg. Pull the leg *away* from the bottom of the computer until it reaches its closed position.

Don't forget your power cord and whatever peripherals, cables, and accessories you want to take with you.

Chapter 3: Connecting Peripherals to Your GRiD Compass

This chapter describes how to connect the following peripherals to your GRiD Compass (for more information, consult each peripheral manual):

- 2101 Disk System
- Portable Diskette Drive
- Epson MX-80, MX-82, FX-80, FX-100, and MX-100 printers
- Diablo 620 and 630 API printers
- Hewlett-Packard 7225A and 7225B, 7470A, 9872C and 9872T plotters
- Hewlett-Packard ThinkJet Printer 2225A

For peripherals not mentioned in this chapter, see Appendix B.

NOTE: The following Dysan Corporation 5 ¼ diskette is the *only* diskette recommended for use with your Disk System or Portable Diskette Drive: 104/2D; Two Sided; Double Density; Soft Sector; 48TPI.

Choosing the GPIB or Serial Connector When connecting your peripheral to the GRiD Compass, you must use either the GPIB connector or the serial connector, located on the rear panel (see Figure 1-3).

The GPIB connector is for peripherals that require an IEEE-488 connector. The Disk System, Portable Diskette Drive, Epson printers, GRiD-supplied Diablo 630 API printer, and Hewlett-Packard plotters should be connected to the GPIB connector (see Figure 3-1).

Figure 3-1. Peripherals Connected to GPIB Connector

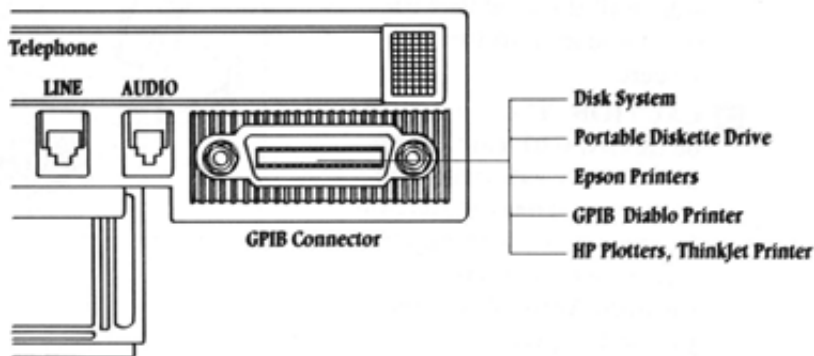

The serial connector is for peripherals that require an RS-232C or RS-422 connector. Any Diablo printer purchased from a source other than GRiD Systems should be connected to the serial connector. External modems should also be connected to the serial connector (see Figure 3-2).

Figure 3-2. *Peripherals Connected to Serial Connector*

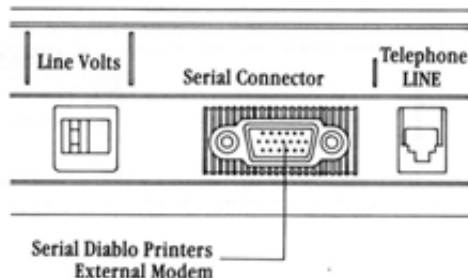

NOTE: When connecting a peripheral not listed above, always consult its manual to see what type of connector you should use.

Connecting Peripherals to the GPIB Connector Use a GPIB cable to hook your peripheral to the GPIB connector.

To connect your peripheral, attach the end of the GPIB cable that has the GRiD logo to the GPIB connector on the back of the GRiD Compass. Attach the cable's other end to the GPIB connector on the back of the peripheral. Because of its trapezoidal shape, the cable will plug into the connector in only one way. If it doesn't fit in easily the first time, turn the end of the cable upside down. Use your fingers to tighten the screws. Never use a screwdriver; you may damage the connector.

Figure 3-3 shows a GPIB cable connecting the 2101 Disk System to the GRiD Compass.

Figure 3-3. GPIB Cable Connecting GRiD Compass to 2101 Disk System

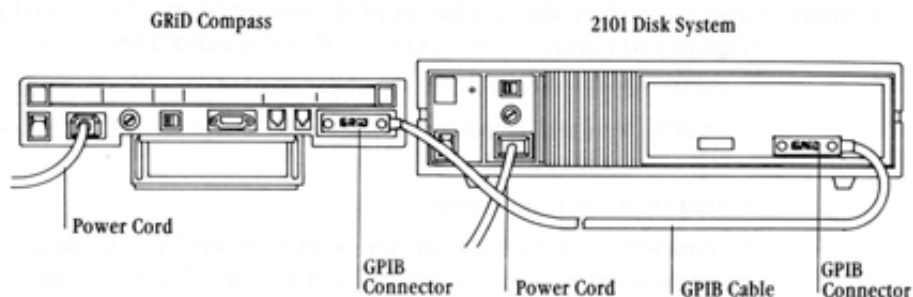

To connect additional peripherals to the GRiD Compass, attach only one GPIB cable to the computer and not more than two cables to any peripheral. Figure 3-4 shows three peripherals connected to the GRiD Compass.

Figure 3-4. Three Peripherals Connected to GRiD Compass

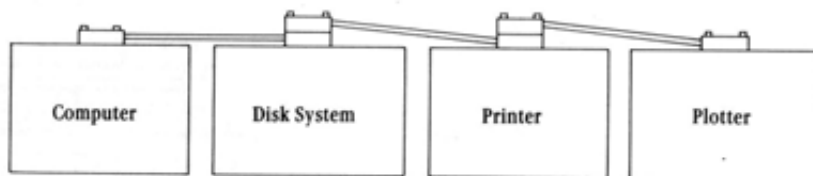

The order in which you connect peripherals is not important as long as they are all linked together. In Figure 3-4, the Disk System and printer have two GPIB cables connected to them. Figure 3-5 shows two GPIB cables connected together. Simply fit one connector on top of the other and tighten the screws with your fingers.

Figure 3-5. Two Connected GPIB Cables

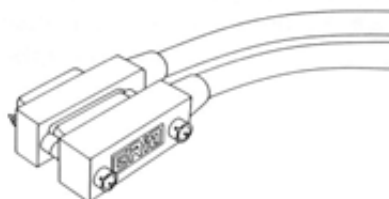

Connecting Peripherals to the Serial Connector Two serial cables are required to connect your peripheral to the serial connector:

- GRiD-supplied model 6100 cable adapter

NOTE: You will need the model 6101 cable adapter if you are connecting an external modem.

- IBM PC-to-printer cable

To connect your peripheral, screw the smaller end of the model 6100 cable adapter into the serial connector on the back of the GRiD Compass. Connect the cable's larger end to the IBM PC-to-printer cable. Attach the other end of the IBM PC-to-printer cable to the RS-232C or RS-422 connector on the back of the peripheral.

Figure 3-6 shows the serial cables connecting the Diablo 630 API to the GRiD Compass.

Figure 3-6. *Serial Cables Connecting GRiD Compass to Diablo 630 API Printer.*

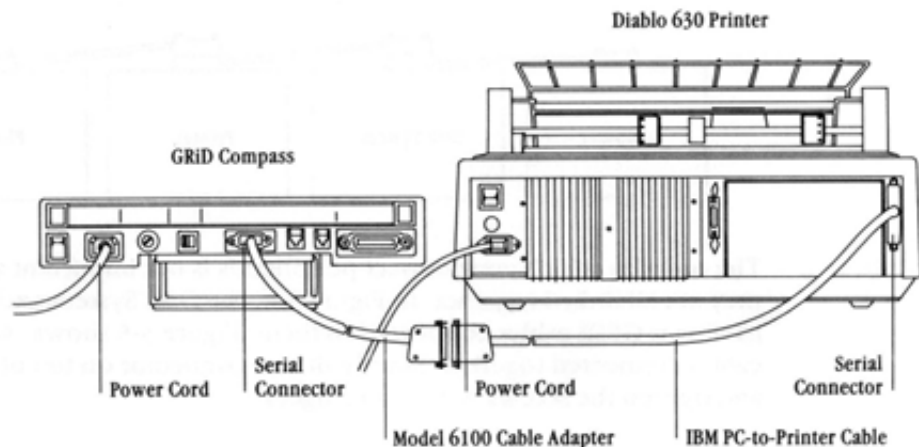

NOTE: Only one peripheral at a time may be connected to the GRiD Compass through the serial connector. Unlike the GPIB connector, the serial connector cannot accommodate peripherals in a chain.

Connecting the 2101 Disk System Figure 3-7 shows the front and rear views of the 2101 Disk System.

Figure 3-7. *Front and Rear Views of the 2101 Disk System*

Front View

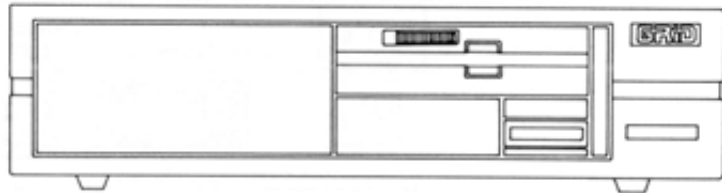

Rear View

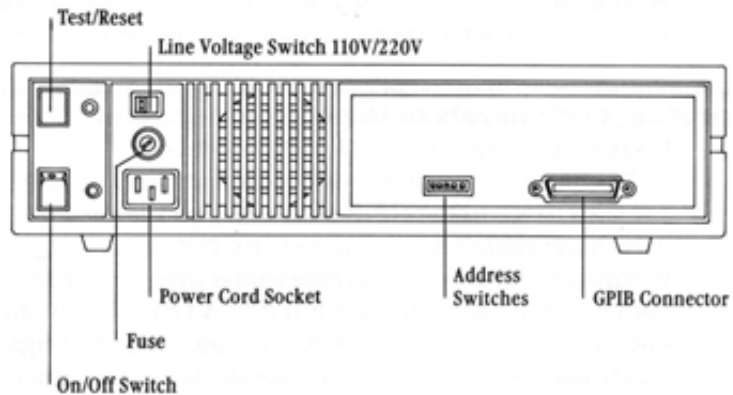

The address switches must be set as shown in Figure 3-8. For the Disk System to function properly, Switch 3 is on and the other switches (1, 2, 4, and 5) are off. These switches set an address that allows the computer to exchange data with the peripheral.

Figure 3-8. *Switch Settings for 2101 Disk System*

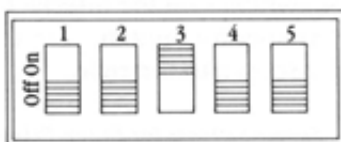

NOTE: If you are connecting more than one disk system, see Appendix B to determine the correct switch settings.

You should also make sure the line voltage switch on the Disk System is set properly. After these switches are set, you are ready to connect the Disk System to the GRiD Compass.

To Connect the 2101 Disk System to the GRiD Compass

1. Turn off the computer, the Disk System, and any other peripherals.
2. Attach one end of the GPIB cable to the connector on the back of the Disk System.
3. Attach the other end of the GPIB cable to the GPIB connector on the back of the computer. Only one GPIB cable should be attached to the computer. If a device is already connected to the computer, connect the GPIB cable to another device's GPIB connector. The order in which you connect peripherals is not important as long as they are all linked together.

NOTE: Attach only one GPIB cable to the GRiD Compass and not more than two cables to any peripheral.

4. Make sure all power cords are plugged in.
5. Turn on the Disk System (and any other peripherals) and then turn on the computer.

Connecting the Portable Diskette Drive Figure 3-9 shows the front and rear views of the Portable Diskette Drive.

Figure 3-9 Front and Rear Views of the Portable Diskette Drive

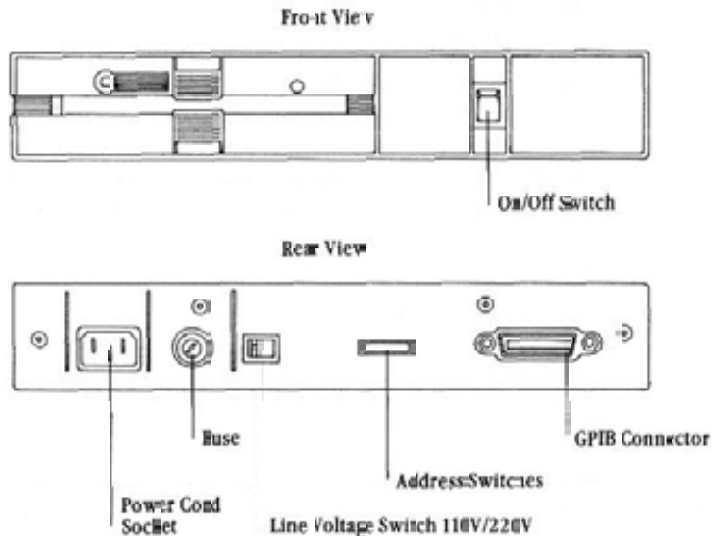

The address switches must be set as shown in Figure 3-10. For the Portable Diskette Drive to function properly, switches 3 and 4 are on and the other switches (1, 2, and 5) are off. These switches set an address that allows the computer to exchange data with the Portable Diskette Drive.

Figure 3-10 Switch Settings for Portable Diskette Drive

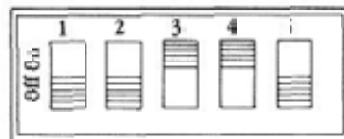

NOTE: If you are connecting more than one portable diskette drive, see Appendix B to determine the correct switch settings.

You should also make sure the line voltage switch on the Portable Diskette Drive is set properly. After these switches are set, you are ready to connect the Portable Diskette Drive to the GRID Compass.

To Connect the Portable Diskette Drive to the GRiD Compass

1. Turn off the computer, Portable Diskette Drive, and any other peripherals.
2. Attach one end of the GPIB cable to the connector on the back of the Portable Diskette Drive.
3. Attach the other end of the GPIB cable to the GPIB connector on the back of the computer. Only one GPIB cable should be attached to the computer. If a device is already connected to the computer, connect the GPIB cable to another device's GPIB connector. The order in which you connect peripherals is not important as long as they are all linked together.

NOTE: Attach only one GPIB cable to the GRiD Compass and not more than two cables to any peripheral.

4. Make sure all power cords are plugged in.
5. Turn on the Portable Diskette Drive (and any other peripherals) and then turn on the computer.

Connecting the Epson Printers Figure 3-11 shows the front and rear views of the Epson FX-80 printer.

Figure 3-11. *Front and Rear Views of the Epson FX-80 Printer*

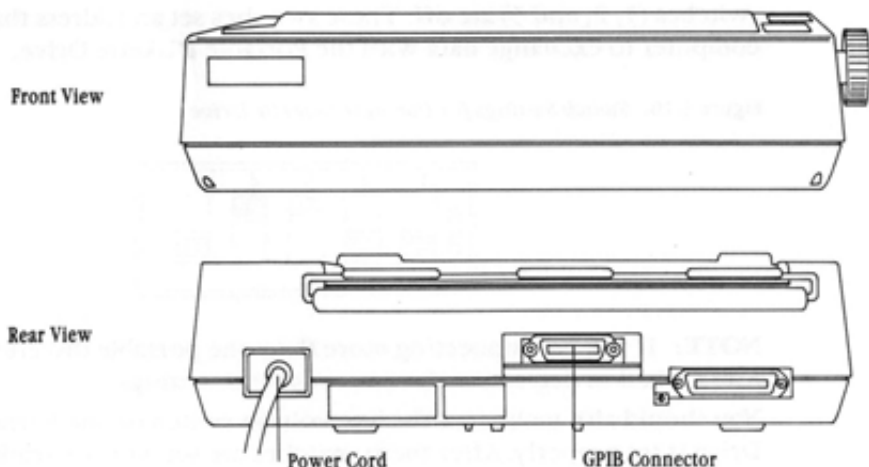

If you obtained your Epson printer from GRiD Systems, it is already equipped to work with the GPIB cable. If you obtained your printer elsewhere, you must also obtain Epson's IEEE-488 Interface Board and install it in the printer. This board is not available from GRiD; it can be purchased from the store where you bought your printer. The Epson manual that comes with the board gives installation instructions. You must make sure the address switches on the interface board are set as shown in Figure 3-12. The settings for Switch 1 are shown to the left; the settings for Switch 2 are shown to the right.

Figure 3-12. Switch Settings for Epson Printers

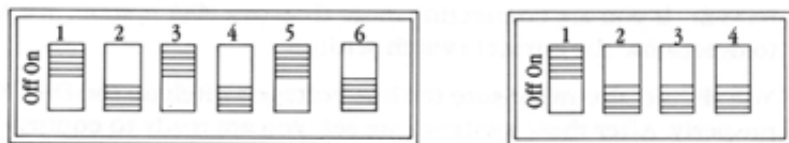

To Connect Epson Printers to the GRiD Compass

1. Turn off the computer, the printer, and any other peripherals.
2. Attach one end of the GPIB cable to the connector on the back of the printer.
3. Attach the other end of the GPIB cable to the GPIB connector on the back of the computer. Only one GPIB cable should be attached to the computer. If a device is already connected to the computer, connect the GPIB cable to another device's GPIB connector. The order in which you connect peripherals is not important as long as they are all linked together.

NOTE: Attach only one GPIB cable to the GRiD Compass and not more than two cables to any peripheral.

4. Check your Epson manual for instructions on loading the ribbon and paper into the printer.
5. Position your paper so that the print head is at the top of a new page (the perforated edge).

Figure 3-13. Paper Aligned in Epson Printer

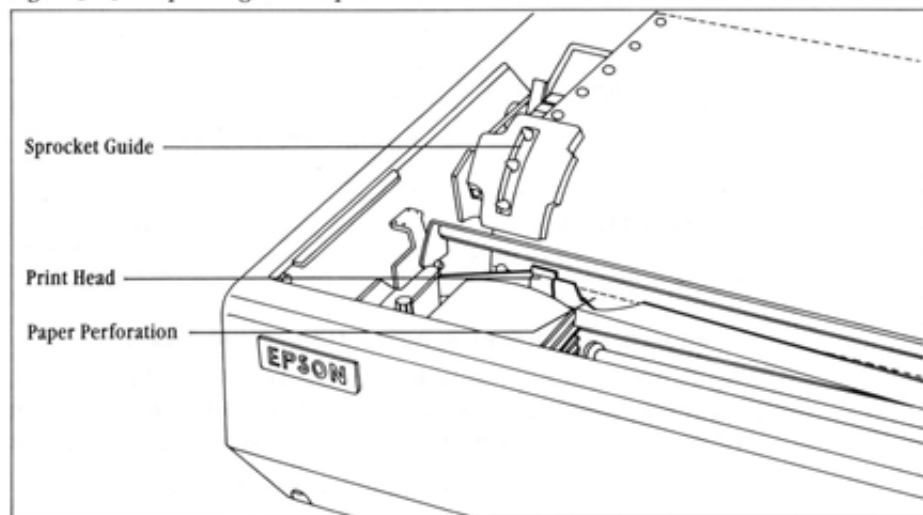

6. Make sure all power cords are plugged in.
7. Turn on the printer (and any other peripherals) and then turn on the computer.

To print a document, you must make sure that the printer's ON LINE light is lit.

Connecting the Diablo Printers

Figure 3-14 shows the front and rear views of the Diablo 630 API printer.

Figure 3-14. Front and Rear Views of the Diablo 630 API Printer

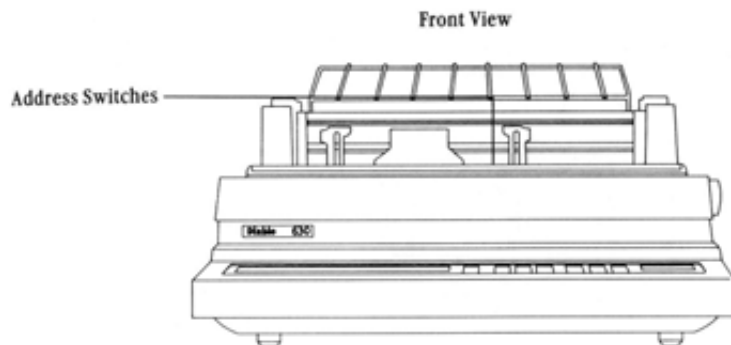

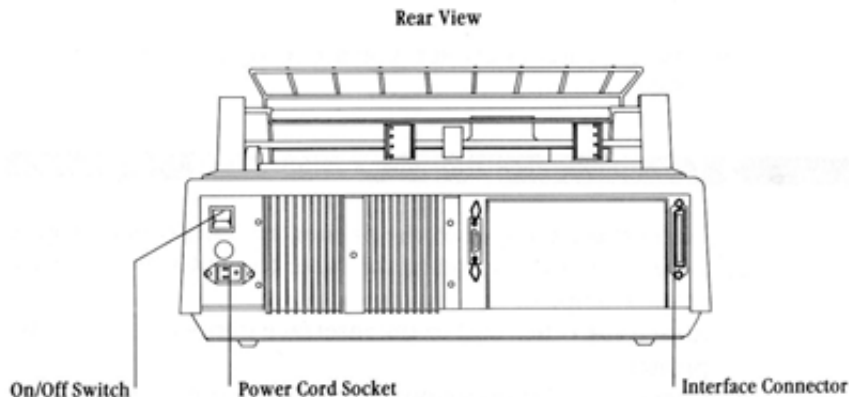

The address switches must be set as shown in Figure 3-15. These switches set an address that allows the computer to exchange data with the Diablo printer.

Figure 3-15. Switch Settings for Diablo Printers

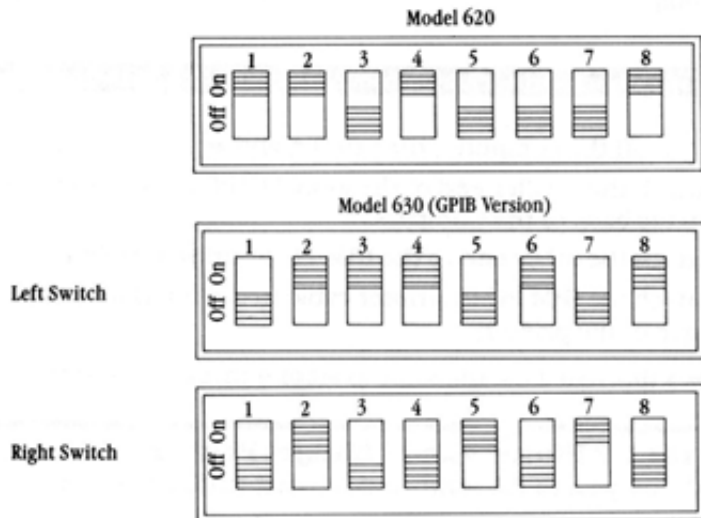

NOTE: The switch settings for the Diablo Model 630 Serial Version are as follows:

Left Switch	All switches off
Right Switch	3, 7 on 1, 2, 4, 5, 6, 8, off

After these switches are set, you are ready to connect the Diablo printer to the GRiD Compass.

To Connect the GPIB Diablo Printer to the GRiD Compass

1. Turn off the computer, the printer, and any other peripherals.
2. Attach the smaller end of the cable to the GPIB connector on the back of the Compass.
3. Attach the other end to the interface connector on the back of the printer.
4. Check your Diablo manual for instructions on loading the ribbon and paper into the printer.
5. Position your paper so that it is under the print bail (the bar that holds the paper against the platen of the printer).
6. Make sure all power cords are plugged in.
7. Turn on the printer (and any other peripherals) and then turn on the computer.

To Connect the Serial Diablo Printer to the GRiD Compass

1. Turn off the computer, the printer, and any other peripherals.
2. Attach the smaller end of the model 6100 cable to the serial connector on the back of the Compass.
3. Attach the other end to the IBM PC-to-printer cable.
4. Attach the IBM PC-to-printer cable to the interface connector on the back of the printer.

Steps 5 through 8 are the same as steps 4 through 7 above.

Connecting the HP Plotters and ThinkJet Printer You can connect your GRiD Compass to the following Hewlett-Packard plotters:

- Models 7225A and 7225B (single-pen)
- Model 7470A (two-pen)
- Models 9872C and 9872T (eight-pen)

Figure 3-16 shows the rear view of the Hewlett-Packard 7470A plotter.

Figure 3-16. Rear view of the Hewlett-Packard 7470A Plotter

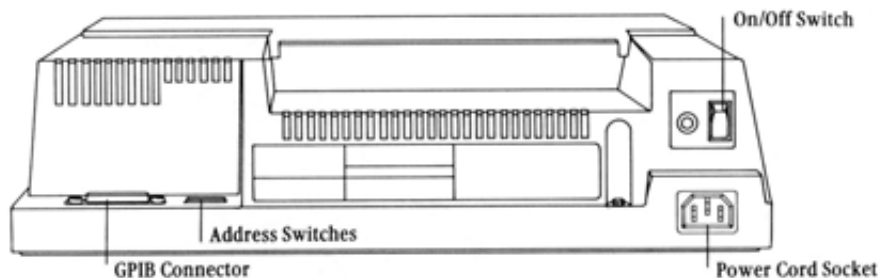

The address switches must be set as shown in Figure 3-17.

NOTE: The order of the switches may be reversed from one plotter to another. Switch 1 appears on the left for Model 9872C, on the right for Model 7225A. However, the setting for each switch is always the same.

Figure 3-17. Switch Settings for Hewlett-Packard Plotters

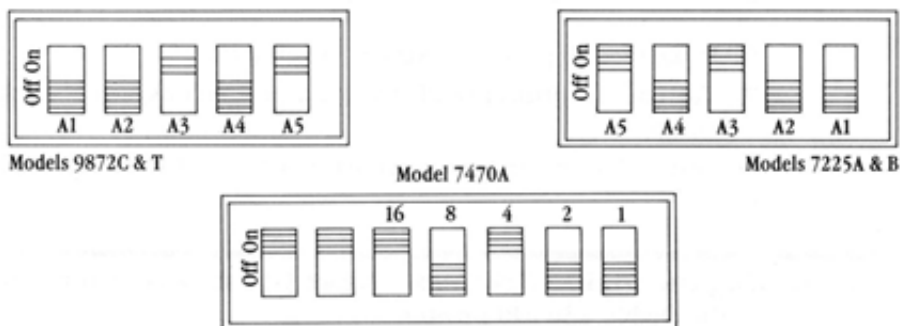

You can also connect your Compass to the ThinkJet Printer, Figure 3-18.

Figure 3-18. Rear View of the Hewlett-Packard ThinkJet Printer

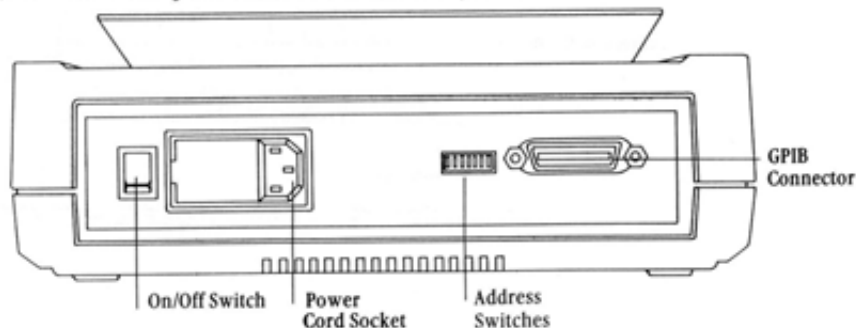

The address switches must be set as shown in Figure 3-19. For the ThinkJet printer to function properly, switches 3, 5, and 7 are on and the other switches (1, 2, 4, and 6) are off. These switches set an address that allows the computer to exchange data with the printer.

Figure 3-19. *Switch Settings for Hewlett-Packard ThinkJet Printer*

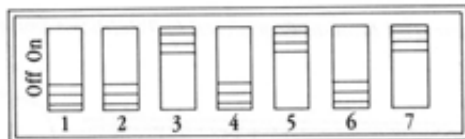

To Connect the HP Plotter or ThinkJet Printer to the GRiD Compass

1. Turn off the computer, the plotter, or printer (and any other peripherals).
2. Attach one end of the GPIB cable to the connector on the back of the plotter or printer.
3. Attach the other end of the GPIB cable to the GPIB connector on the back of the computer. Only one GPIB cable should be attached to the computer. If a device is already connected to the computer, connect the GPIB cable to another device's GPIB connector. The order in which you connect peripherals is not important as long as they are all linked together.

NOTE: Attach only one GPIB cable to the GRiD Compass and not more than two cables to any peripheral.

4. Check your Hewlett-Packard manual for instructions on how to set up the plotter.
5. Make sure all power cords are plugged in.
6. Turn on the plotter or printer (and any other peripherals) and then turn on the computer.

Chapter 4: Using the Modem and Telephone Handset

This chapter describes how to use the GRiD Compass modem and telephone handset.

What Is a Modem? The GRiD Compass uses a built-in *modem*, a device used to transmit and receive data or voice through the telephone system. The modem operates through any standard telephone system at either 300 or 1200 bits per second.

With the appropriate software, you can communicate with the following computers inside and outside the GRiD family of products (Figure 4-1).

Figure 4-1. *Communication Inside and Outside the GRiD Family of Products*

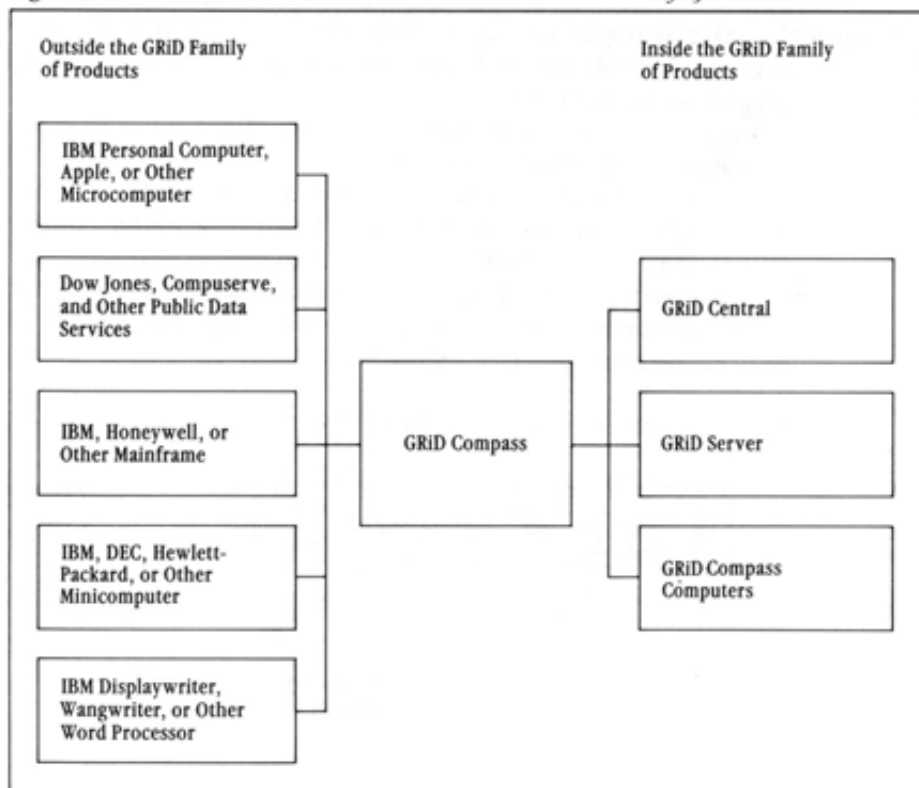

Notifying the Telephone Company The Federal Communications Commission (FCC) requires that you contact your local telephone company before using telephone lines to transmit data. The telephone company will want the following information for any telephone number from which you operate the computer.

- Manufacturer—GRiD Systems Corporation
- Equipment model number—1101 or 1109
- FCC registration number—AJ496M 70322-DM-E

This number is printed on a sticker inside the storage well that holds the leg.

- Ringer equivalence—0.9B

Connecting the Telephone Line The GRiD Compass has two telephone connectors. Your phone cord plugs into the slot marked LINE. The handset plugs into the AUDIO slot.

Each connector is a different size. If the plug doesn't fit in easily, you are probably trying to fit it in the wrong slot.

Most offices and residences now use the standard plug-in jack connector (RJ11C). If you have the older, four-prong phone connector, you will need an adapter to plug into the LINE slot.

To connect your GRiD Compass to the telephone system, unplug the cord from the back of your telephone and plug it into the LINE slot on the back of the computer (see Figure 4-2).

Figure 4-2. GRiD Compass Connected to Phone Jack

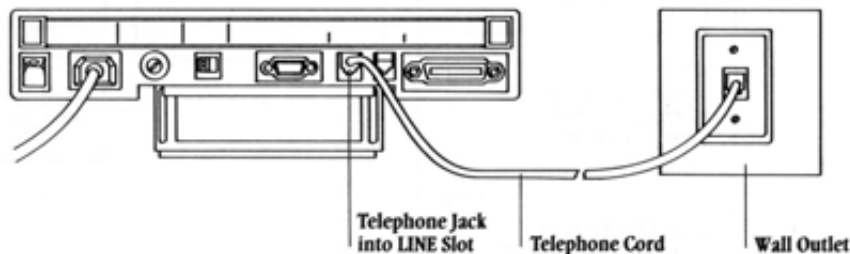

To use your telephone while your computer is connected, you will need a T-connector (available from GRiD) and another telephone cord. Unplug the telephone cord from the back of your phone and plug the T-connector into its place. Now plug both the original telephone cord and the extra telephone cord into the T-connector. Plug the other end of both cords into the GRiD Compass. See Figure 4-3.

Figure 4-3. *Phone and Modem Connected to Telephone System*

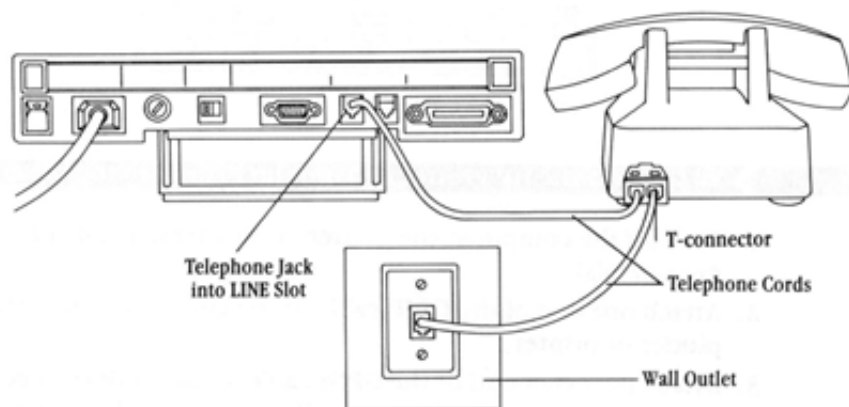

You can now use your telephone line either to speak on the phone or to transmit and receive data from another computer.

NOTE: If your modem is not working properly, see the Appendix "Testing the Modem" to determine if it is your modem or telephone line that is causing the problem.

Adjusting the Speaker Volume When using the modem to access another computer, the GRiD Compass has an automatic dialing feature. After you fill in the appropriate form, the GRiD Compass will dial the number automatically. You may want to adjust the volume of the sounds made during dialing. You can set the volume to "Off," "Low," "Medium," or "High."

When signing on to GRiD Central or GRiD Server, you adjust the speaker volume with the Speaker Volume item on the Sign-on form in GRiDManager as described in the *GRiD Management Tools Reference*.

When using GRiDTerm, GRiD3101 or GRiDV100, you adjust the speaker volume with the Speaker Volume item on the Access form as described in the user's guides provided with each product.

The Telephone Handset A telephone handset can also be connected to your GRiD Compass so that you can make and receive telephone calls. An optional accessory, the handset is available at your local GRiD office. Regular telephone handsets won't operate properly with your GRiD Compass.

Plug your handset into the AUDIO slot on the back of the GRiD Compass (see Figure 4-4).

Figure 4-4. *Telephone Handset Connected to GRiD Compass*

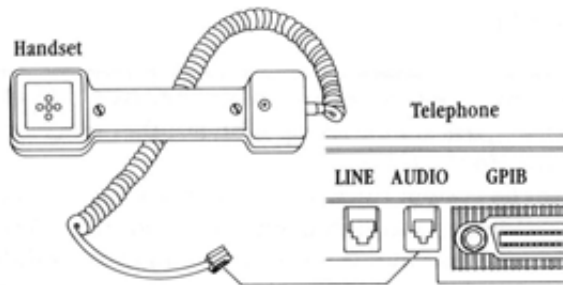

A cradle is provided with your handset. You can rest your handset on the cradle whenever you are not using it. The cradle hooks onto either side of the GRiD Compass (see Figure 4-5).

Figure 4-5. *Handset Resting on Cradle*

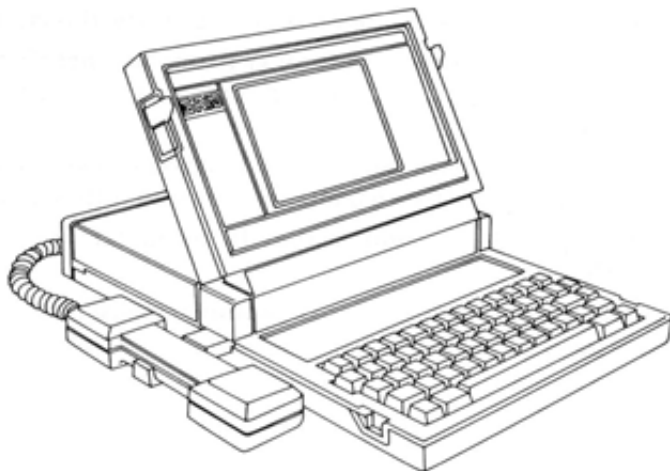

Chapter 5: Troubleshooting

This chapter describes problems that might arise as you use your GRiD Compass and provides tips on how to resolve them.

Identifying the Problem There are generally two types of problems: problems with computer hardware or software, and problems due to user errors.

User Errors in Setting Up the GRiD Compass

Table 5-1 lists common problems you might encounter when setting up your computer system. To use the table, look for your problem under the heading Symptom, identify the cause, and follow the suggested remedy.

Table 5-1. *Troubleshooting Chart*

Symptom	Cause	Remedy
No response when GRiD Compass is turned on	Not plugged in	Check that the power cord is firmly connected to GRiD Compass rear panel and to wall outlet.
	Bad fuse	Replace with correct fuse. In U.S.A. — one-ampere fuse. (See Chapter 1.)
	Line Voltage setting incorrect	Set to correct line voltage. In U.S.A. — 110 volts.
No response when peripheral is turned on	Not plugged in	Plug in power cord.
	Hardware not functioning	Run a self-test. (See manual that comes with each peripheral.)
	Cables not hooked up correctly	Connect cables securely and properly. (See Chapter 3.)
	Address switches set incorrectly	Check that address switches are set properly. (See Chapter 3.)

Symptom	Cause	Remedy
GRiD Compass slow to respond	With GRiD-OS system takes about 40 seconds to load memory	Be patient.
	With MS-DOS, system takes from 3 to 45 seconds to load memory	Be patient.
Incorrect date or time on screen	Time-of-day clock set incorrectly	Set correctly. (For GRiD-OS users, see <i>Getting Started with the GRiD Compass</i> . For MS-DOS users, see <i>GRiD Compass MS-DOS User's Guide</i> .)

If, after consulting the troubleshooting chart, you've determined the problem is not due to a user error, try to determine whether it is a software or hardware problem.

Software or Hardware Problems

- CAUTION:** Your GRiD Compass must have the correct software to work properly when you first turn it on.

If you are using GRiD-OS, you always need the following files in your Programs subject, regardless of the application you use:

Title	Kind
<input type="checkbox"/> CCOS (GRiD-OS)	System
<input type="checkbox"/> Common	Shared
<input type="checkbox"/> Executive	Run

For communications with GRiD Central and GRiD Server, you need the following files in your Programs subject:

<input type="checkbox"/> GRiDManager	Run Sign-on
<input type="checkbox"/> PhoneLink	Device
<input type="checkbox"/> Modem	Device

NOTE: You don't need PhoneLink and Modem when you use GRiDLink to connect with GRiD Server.

If you are using MS-DOS, you need the MS-DOS diskette.

If you have problems with specific software *other than* CCOS, Common, and Executive, you might try erasing the copy of the old software and replacing it with a different copy of the same version.

If this still doesn't work, and if you have ordered a GRiD support service contract with your GRiD Compass, call the GRiD Resource Center at (415) 961-4743.

If you decide your problem is not a set-up or software problem, then it may be a hardware problem. Call the GRiD Resource Center for help with diagnosing.

Dealing With Radio Frequency Interference If you suspect that your GRiD Compass is interfering with another electronic device (such as a TV or radio), do the following:

With the system turned on, watch and/or listen to the device that seems to be picking up radio frequency interference. Turn off the computer. If interference subsides significantly, you may confidently trace your problems to the computer. If no change occurs, the problem lies elsewhere (possibly in the other electronic device itself).

If the computer seems to be the cause, try these methods for lessening interference. Make sure the computer and the other electronic device are turned on to determine if one or more of these suggestions work.

- Change the position of the electronic device's antenna. In the case of radios, this may mean moving the radio itself.
- Move the computer around so it faces a new direction.
- Move the computer farther away from the other electronic device. If this means unplugging the computer, be sure to turn it off before you unplug it.
- Plug either the computer or the electronic device into a different outlet. If possible, plug the two instruments into different outlets.
- If peripherals are connected to the computer, be sure to use shielded cables.

If these solutions still do not produce satisfactory reception, contact your local GRiD office.



Chapter 6: Maintenance

This chapter describes how to care for your GRiD Compass. Although the GRiD Compass is basically durable, you should treat it as you would any precision instrument—with care.

Warnings Observe the following warnings. Not following these warnings could lead to possible physical injury.

- Do not operate the computer in a dirty or dusty environment.
- Do not get the computer wet; electrical equipment should not be operated in a moist environment.
- Do not operate your computer in any potentially flammable atmosphere.
- Do not attempt to open the computer case; it contains no user-serviceable parts. Such action voids your warranty and can damage the computer.
- Arrange any power cords or other cords so they can't be pulled out or tripped over when the computer is in use.
- Make sure you properly ground any power-plug adapter.
- To protect the computer against risk of fire, replace the fuse only with one of the same rating and type. In the U.S.A., use a one-ampere slow-blow (AT) fuse for 110-volt operation. Outside the U.S.A., use a 500-milliamperere, super slow-blow (ATT) fuse for 220-volt operation. For instructions on fuse replacement, see the Fuse section in Chapter 1.
- Always turn off the computer before unplugging it.
- Always turn off the computer and unplug before installing or removing it.
- To operate the unit in the U.S.A., the power requirements are 90–140 Volts Alternating Current (VAC), 47–66 Hertz (Hz), 1.0 Ampere (A), 75 Watts (W). Outside the U.S.A., 160–280 VAC, 47–66 Hz, .5 A, 75 W.

Cautions Observe the following cautions. Not following these cautions could damage your unit.

- Always unfold the computer's leg. This allows adequate ventilation and puts the keyboard and screen at the proper viewing angle.
- Operate the computer only when the surrounding temperature is from 50° to 104° F (10° to 40° C).

- Operate the computer only when the relative humidity level is from 5% to 95% noncondensing.
- Do not operate the computer when the altitude exceeds 10,000 feet (3,000 meters).
- Store the computer where the surrounding temperature is from -40° to 149°F (-40° to 65°C).
- Do not store the computer in an altitude which exceeds 40,000 feet (12,000 meters).
- Do not store or set up the computer (or its peripherals) in direct sunlight.
- Do not subject the computer to unnecessary shock or vibration.
- When cleaning the computer, never use any cleaning agent such as dust wax, spray cleaner, or any abrasive substance.
- Never turn off the computer when the flags on the lower right corner of the screen are flickering. These flags indicate that the computer is reading or writing data; also, never turn off your computer if a disk unit is attached to it and the in-use light on the unit is lit. Turning off the computer at these times can destroy data.
- Always make sure the line voltage switch is set properly before plugging the power cord into an electrical outlet. Supplying power through an incorrect voltage setting can damage your computer.

Cleaning Your GRiD Compass Before cleaning your GRiD Compass, turn it off and disconnect the power cord from the outlet.

To clean the case, use a slightly damp, soft cloth and, if necessary, a mild, nonabrasive detergent.

- **CAUTION:** Never use any cleaning agent such as dust wax, spray cleaner, or any abrasive substance.

Wipe the case clean and then dry it.

To clean the screen, slightly dampen a soft cloth with an ammonia-based glass cleaner and gently wipe the screen. Use the cleaner sparingly so that no fluid runs down the screen and into the frame.

If necessary, dust the rear panel of your GRiD Compass with a dry cloth.

- **WARNING:** To prevent shock hazard, *never* apply any liquid to the rear panel.

Storing Your GRiD Compass Always store your GRiD Compass between the temperatures -40° and 149°F (-40° to 65°C). To keep it free from dust and dirt, store it in the carrying case that comes with each GRiD Compass.

Traveling With Your GRiD Compass When traveling with your GRiD Compass, carry it with you instead of checking it as luggage. Many transportation carriers cannot cover the replacement cost of your GRiD Compass should they lose or damage it.

It should be relatively safe to x-ray the GRiD Compass in airport security checks, but you must make the final decision. You can have it hand-checked, if you wish.

When traveling abroad;

- Be sure to bring a 500-milliamperere, super slow-blow fuse (and its holder) and a European power cord for the different voltage (220–250 volts). These items are available when you purchase GRiD's European Conversion Kit.
 - Before turning on your GRiD Compass, make sure you change to the 500-milliamperere fuse, set the line voltage switch to 220 volts, and replace your power cord with a European power cord. If you are using an adapter, make sure it is properly grounded for nongrounded outlets.
-

Updating the Clock The time-of-day clock, which displays the time and date on your screen, is not intended to replace your wristwatch. The precision of its time-measuring electronics may vary because of temperature changes. Check the time and date of your clock periodically.

If you are using GRiD-OS, see the section Set Time—CODE-? in the "GRiDManager" chapter of the *GRiD Management Tools Reference*.

If you are using MS-DOS, see the chapter "The Settime Command" in the *GRiD Compass MS-DOS User's Guide*.



Appendix A: Testing the Modem

If your modem is not working properly, do the following test to see whether your modem or your telephone line is causing the problem.

This test is divided into two parts. The second part is repeated once.

You must have the GRiDTerm application to perform the test. You cannot perform this test if you need telephone operator assistance to make a phone call.

To Test Your Modem: Part I

1. Plug the telephone line (from the wall jack) into the LINE slot on the back of the computer.
2. Select GRiDTerm from the list of program titles. The Access form appears on the screen.
3. Fill in the Phone Number item with the number for the local time service, local weather service, or some other recorded-voice phone number.
4. Leave the Remote System Name item blank.
5. Set the Baud Rate item to 1200.
6. Set the Modem Type item to Internal.
7. Make sure the Dial Type item is set correctly. The choices are Pulse (rotary dial) and Touch-Tone™.
8. Set the Voice Before Data item to No.
9. Set the Wait For Answer item to 20.
10. Make sure the Speaker Volume item is set to Medium or High.

If the modem does not pause for dial tone at carets (^) or doesn't respond even with a dial tone at a caret, you have a bad modem. You don't need to go further with your testing. Contact your local GRiD sales representative to get your modem repaired.

If you hear the recorded message from the recorded-voice phone number, your modem is working properly. Continue the test.

To Test Your Modem: Part 2

1. With the Access form displayed on the screen, enter the phone number (415) 965-3229 to connect to a loopback modem at the GRiD Resource Center. This modem is used for testing; any data you send to it is automatically transmitted back to you.
2. Change the Baud Rate item to 300.

After confirming the Access form, you should connect to the modem at the GRiD Resource Center within ten seconds. If you don't connect, disconnect and call again. You may have a bad phone line. If you still can't connect to the modem after trying about five more times, your modem is probably bad. To confirm whether your phone line is bad, try the test using a different phone line.

If you do connect to the modem at the GRiD Resource Center, you will see a blank screen with the following message at the bottom:

Data mode established

To make sure your modem is working properly, follow the next step.

3. Type a few characters on the keyboard. If you get an error message, or you see characters other than those you typed, or a different number of characters on the screen than you typed, disconnect and try again. You may have a bad phone line. If you still can't connect to the modem after trying about five more times, your modem is probably bad. Again, to be absolutely sure, you should try the test with a different phone line.

If you haven't had any problems so far, repeat Part 2 to see how your modem functions at 1200 baud rate. This time, set the Baud Rate item on the Access form to 1200 (step 2).

If all of the above steps check out OK, you can be fairly sure your modem functions properly. If you have any trouble with the test, phone the GRiD Resource Center at (415) 961-4743.

Appendix B: Switch Settings on Devices

This appendix gives the switch settings that apply when multiple disk and/or diskette drives are attached to the same Compass, as well as settings for other devices.

Settings on Disk Devices The 2101 Disk System and the Portable Diskette Drive each have a switch on the back side; these switches are set at the factory so that each unit operates either alone or together with the other when attached to a Compass computer. If additional disk and/or diskette drives are attached, the settings shown in Table B-1 apply to the new configuration of devices.

Table B-1. *Switch Settings for 2101 Disk System and Portable Diskette Drive*

Attached Device(s)	Switch Settings	Device Letter
One Portable Diskette Drive	3,4 up 1,2,5 down	A, B
Two Portable Diskette Drives		
1st Unit	3,5 up 1,2,4 down	A, B
2nd Unit	3,4 up 1,2,5 down	E, G
One 2101 Disk System	3 up 1,2,4,5 down	
Hard Disk Drive		C
Diskette Drive		A, B
One 2101 Disk System and One Portable Diskette Drive		
2101	3 up 1,2,4,5 down	
Hard Disk Drive		C
Diskette Drive		A
Portable Diskette Drive	2,3,5 up 1,4 down	B



This page is missing

This page is missing

GRiD Systems Corporation
Mountain View, California 94043